

Article number: 20343525M6KR
Description: E+G levelling foot
GN 343.5-25-M6-KR

Measures

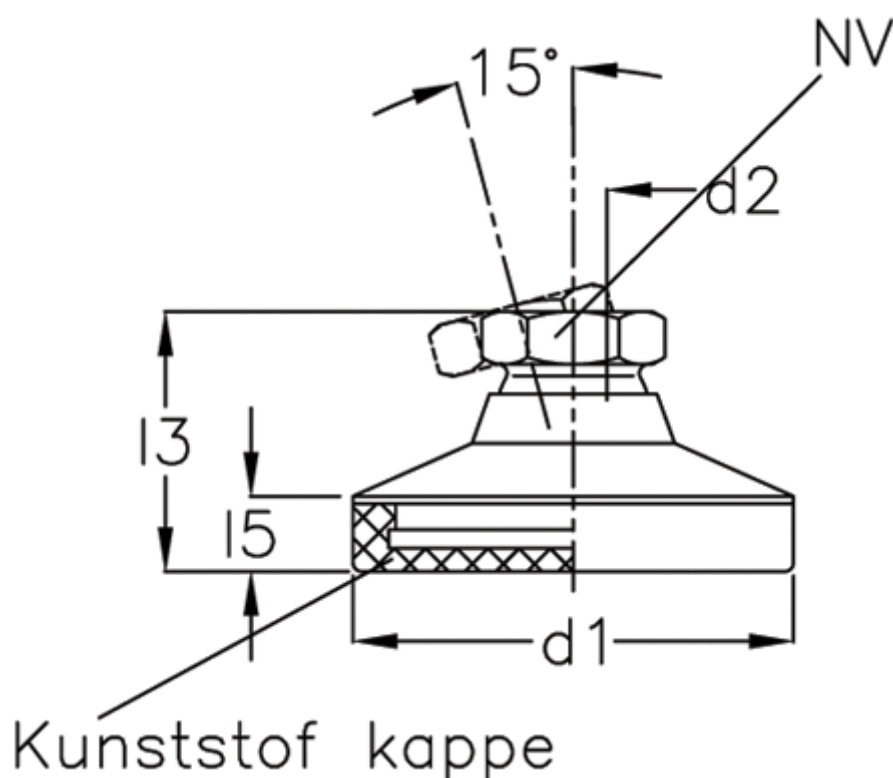

d1	= 25
d2	= 6
l3	= 20.5
l5	= 5.5
NV	= 12
Static load (N)	= 4
t min	= 9